

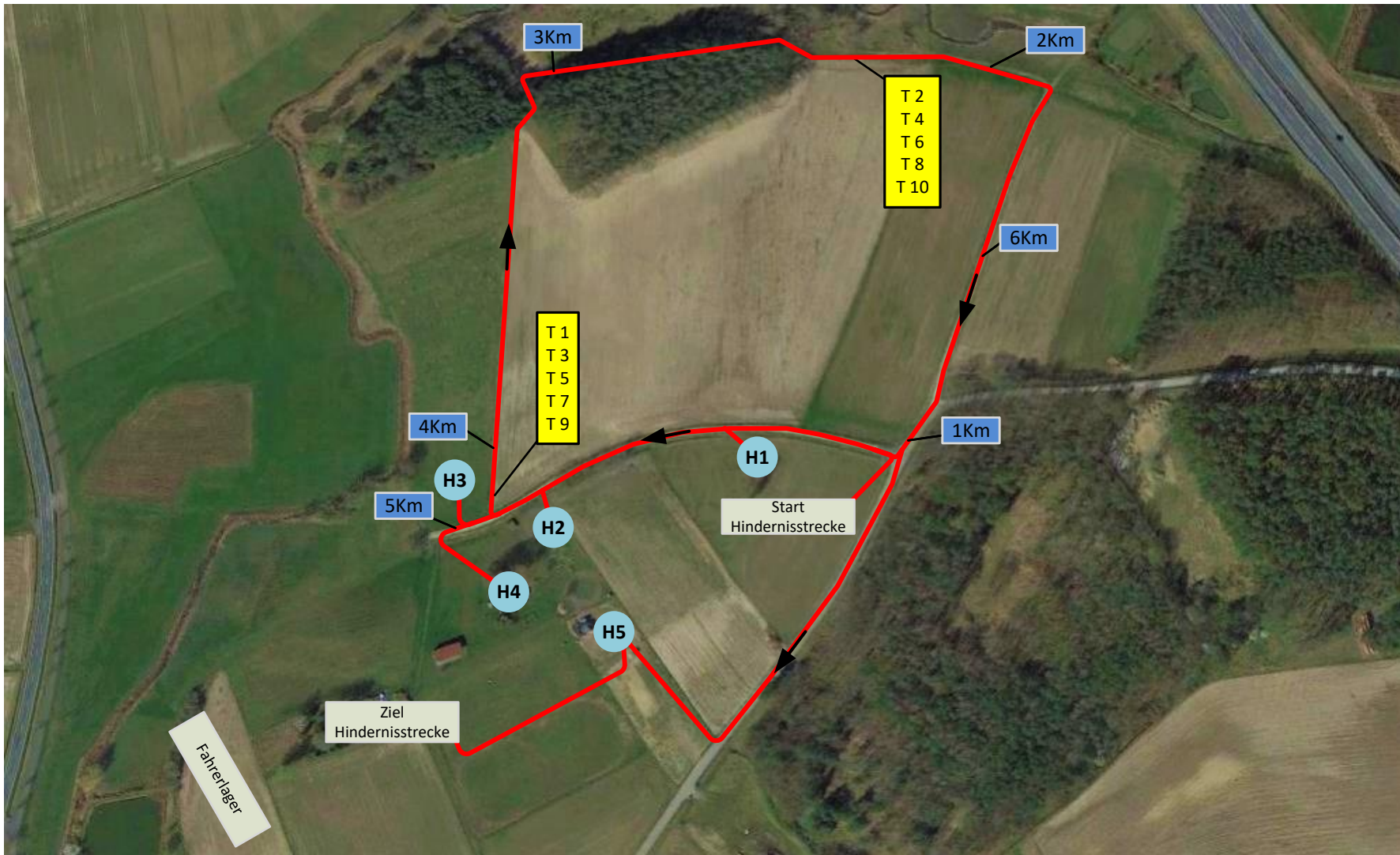

Fränkische Meisterschaft Ein.-u. Zweispänner Kl.M Bay. und Fränkische Meisterschaft Junioren/U25 Bay. Nachwuchschampionat Junioren/U16



Streckenführung Hindernisstrecke Kl.M:

Start - T1 - T2 - 1km - H1 - T3 - T4 - 2km - H2 - T5 - 3km - T6 - H3 - T7 - 4km - T8 - 5km - H4 - T9 - T10 - 6km - H5 - Ziel



Hindernis 1 Birkenwäldchen

Nur Kl:M

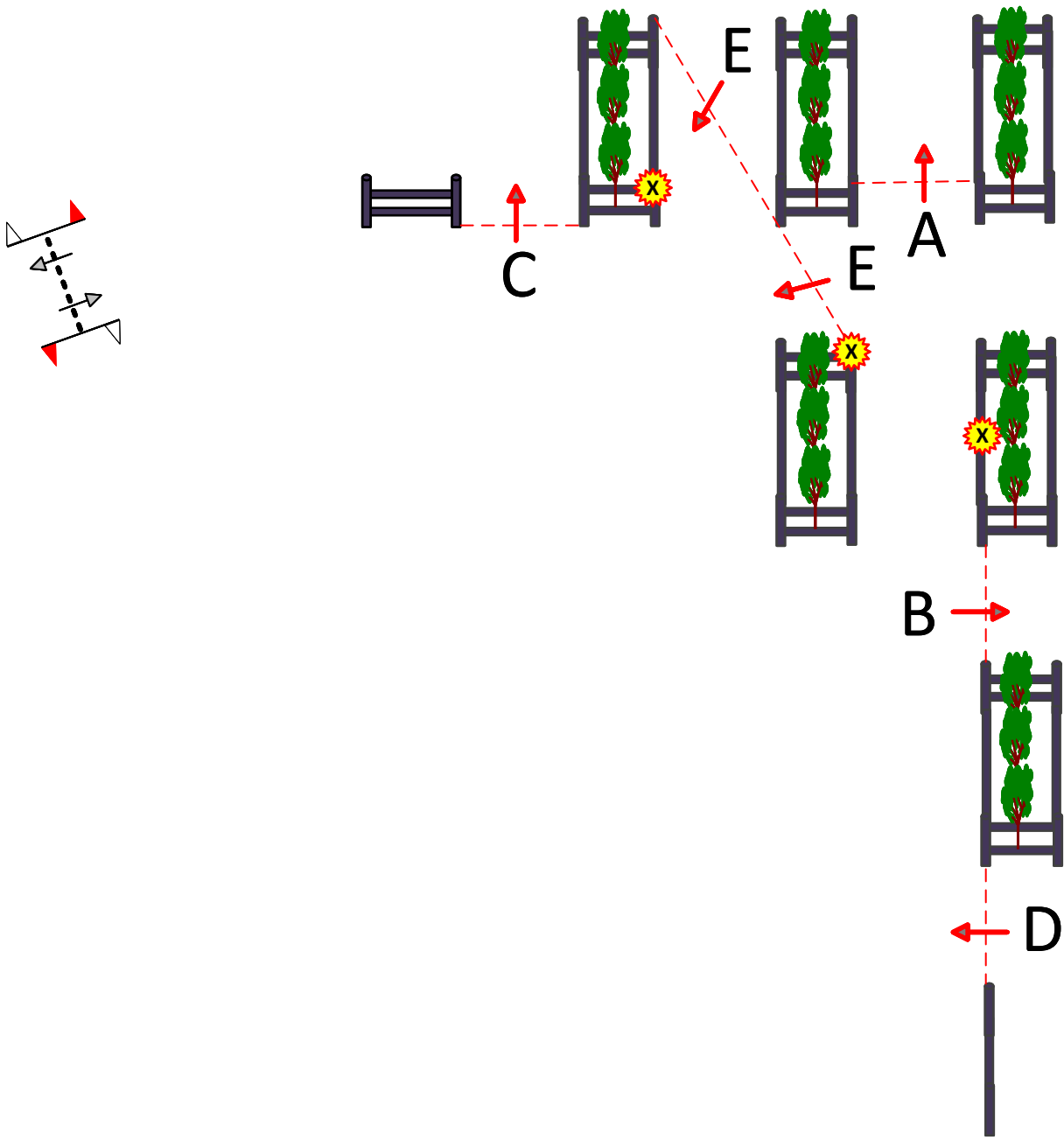

 Kl.M A – E
Abwerfbare Teile 3

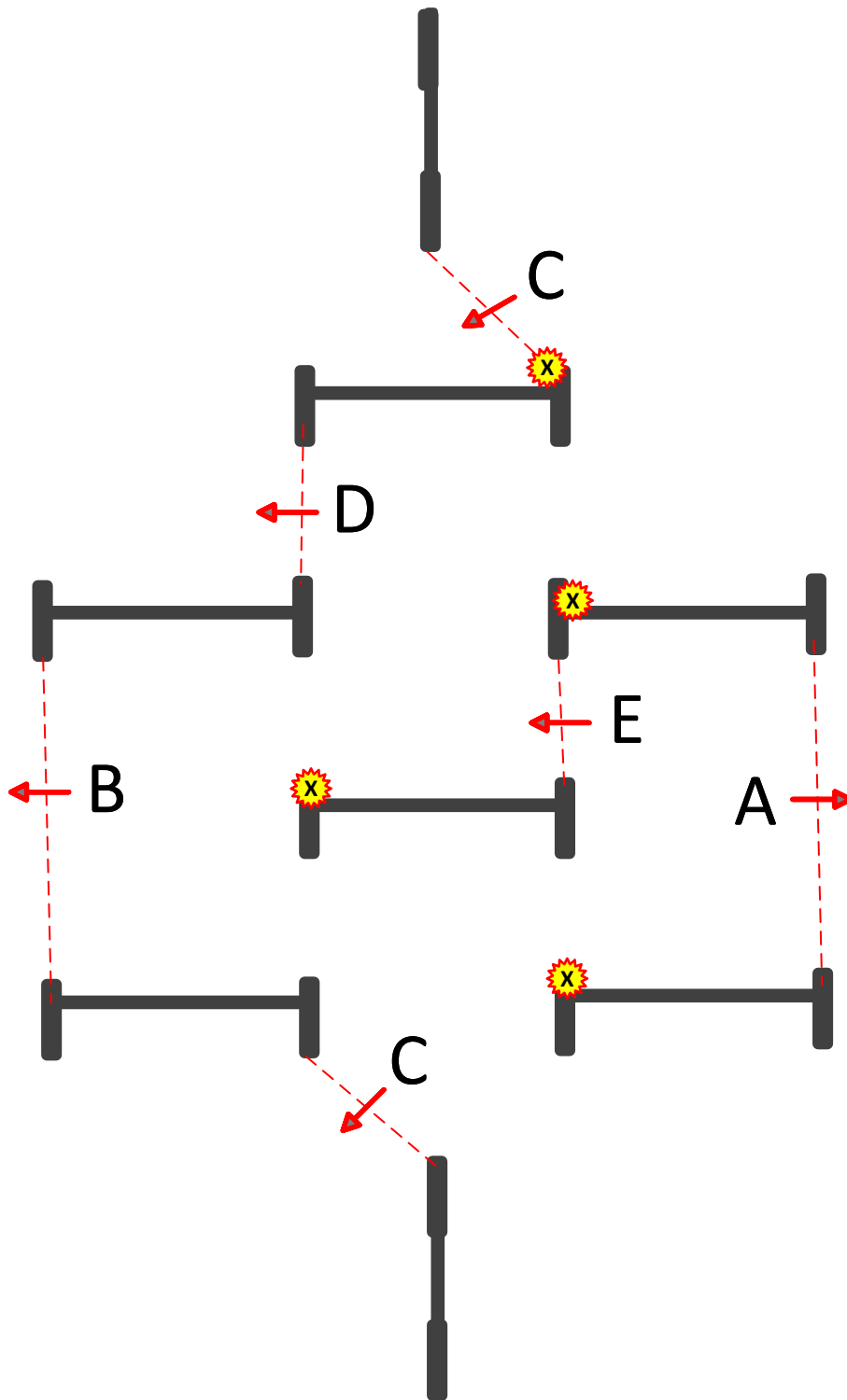
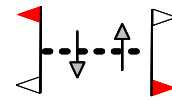

	Kl:A	A – D
	Kl.M	A – E
	Abwerfbare Teile 4	

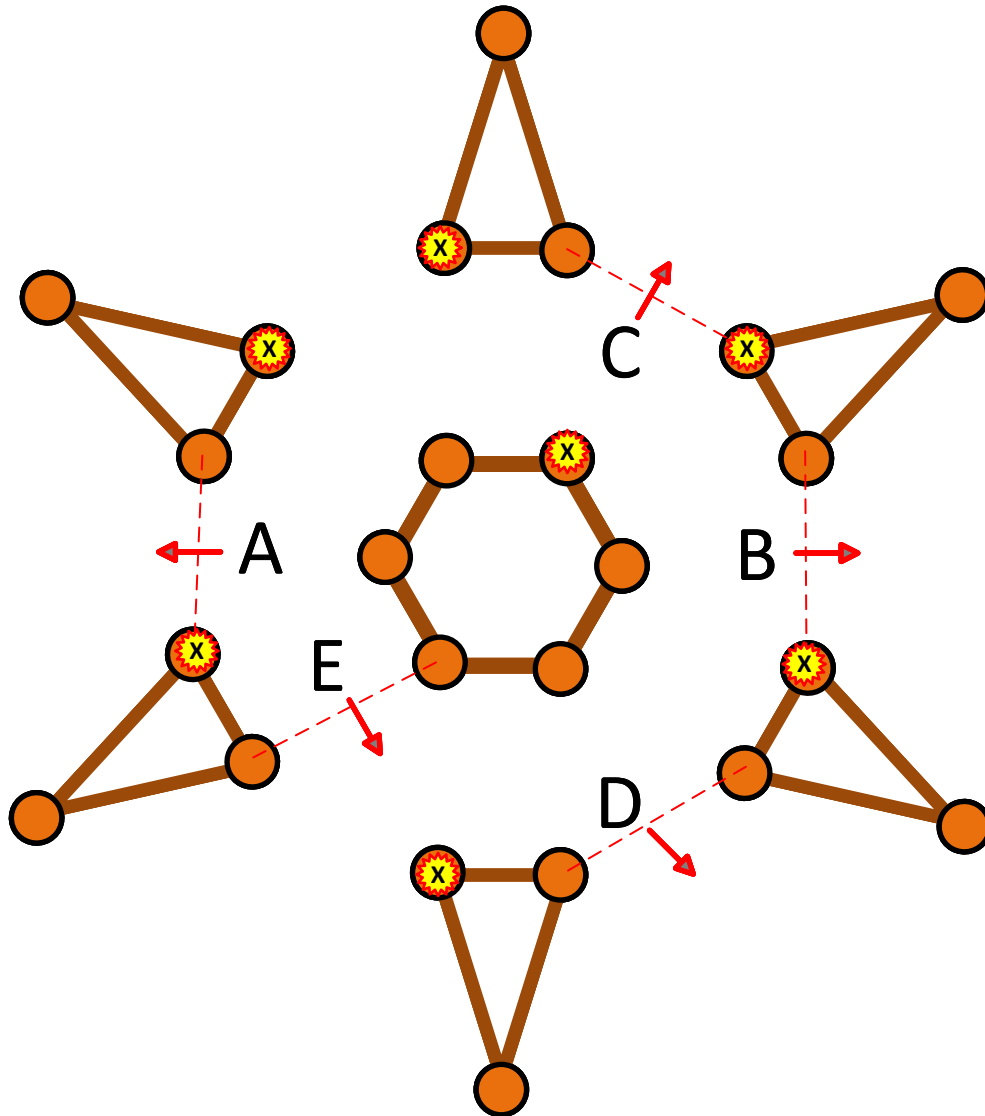

Kl:A	A - D
Kl.M	A - E
	Abwerfbare Teile 7

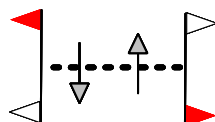

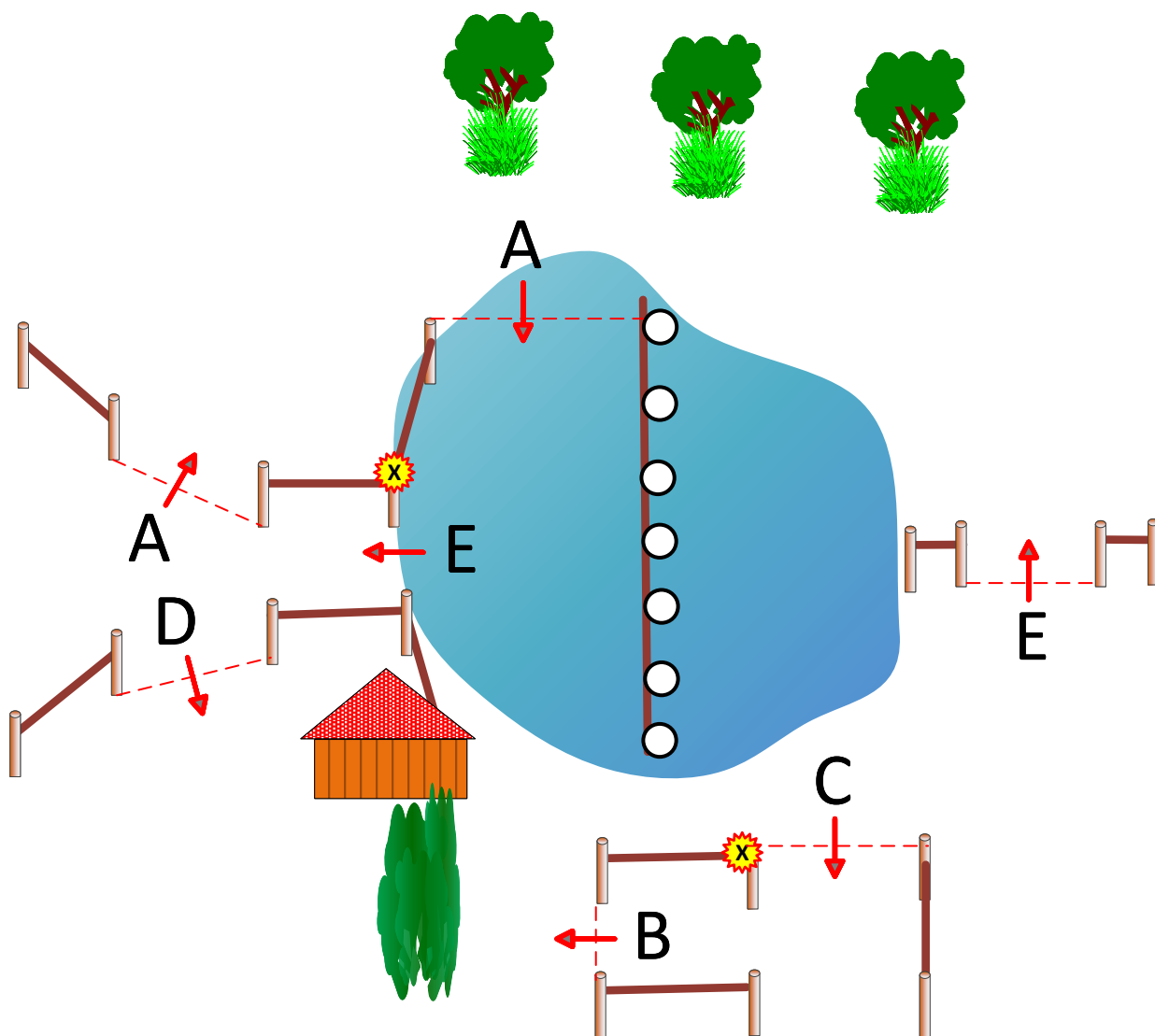
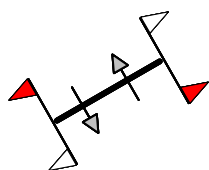

Kl:A A - D
 Kl:M A - E
 Abwerfbare Teile 2

Fränkische Meisterschaft Ein.-u. Zweispänner Kl.M,
Bay. und Fränkische Meisterschaft Junioren/U25, Bay. Nachwuchschampionat Junioren/U16
Niederlindach 13.-15.Aug 2021

© Course Designer: Ludwig Rummelsberger

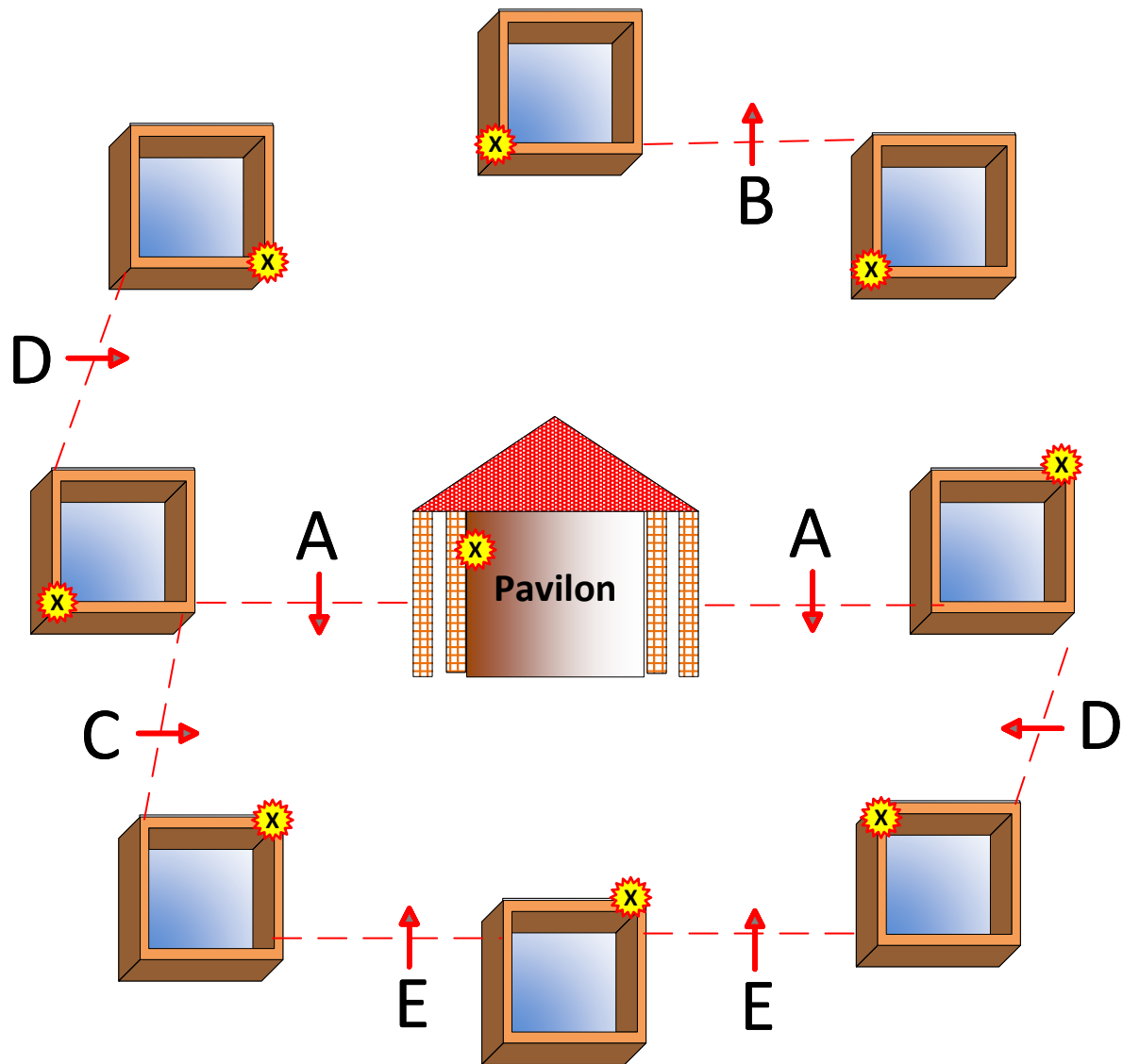

KI:A	A - D
KI:M	A - E
	Abwerfbare Teile 9

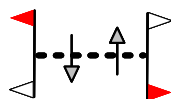

Streckendaten Kl.M

Fränkische Meisterschaft
Bayerische Jugendmeisterschaft



der Ein.-und Zweispänner Kl.A / Kl.M
Niederlindach 13. – 15.Aug. 2021

Prüfung Nr. 2/10		Pferde		Hindernisstrecke Ein.- und Zweispänner Kl.M			
Teilstrecke	Gangart	Länge m	Tempo Km/h	Erlaubte Zeit min:sec	Bestzeit min:sec	Höchstzeit min:sec	Pflichttore
Hindernisstrecke	Beliebig	6700	14	28:43	25:43	57:26	1 bis 10

Streckenführung Hindernisstrecke:
Start - T1 - T2 - 1km - H1 - T3 - T4 - 2km - H2 - T5 - 3km - T6 - H3 - T7 - 4km - T8 - 5km - H4 - T9 - T10 - 6km - H5 - Ziel

Prüfung Nr. 6/15		Ponys		Hindernisstrecke Ein.- und Zweispänner Kl.M			
Teilstrecke	Gangart	Länge m	Tempo Km/h	Erlaubte Zeit min:sec	Bestzeit min:sec	Höchstzeit min:sec	Pflichttore
Hindernisstrecke	Beliebig	6700	13	30:55	27:55	61:50	1 bis 10

Streckenführung Hindernisstrecke:
Start - T1 - T2 - 1km - H1 - T3 - T4 - 2km - H2 - T5 - 3km - T6 - H3 - T7 - 4km - T8 - 5km - H4 - T9 - T10 - 6km - H5 - Ziel



Ein großes „Dankeschön“
an allen Spendern
und Helfern